

Data Sheet



Article number: 021500700073

Description: Sealing Clamp S 73 W5

Measures

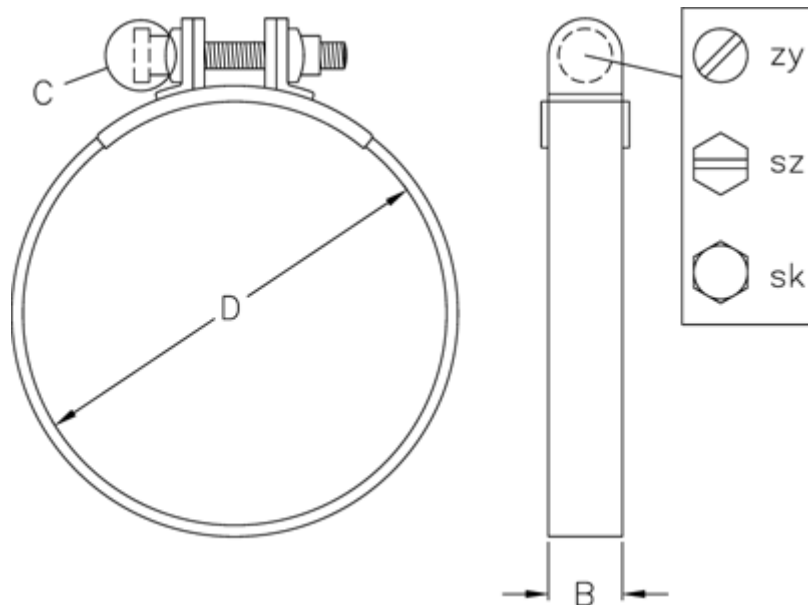

C (screw type) = SZ

Diameter D = 73

Width B = 20